

Contender™ Series Factory Sealed Front Operated Tumbler Switches

Explosionproof, Dust-Ignitionproof

Malleable Iron Body and Cover. Furnished with Internal Ground.

NEC/CEC:

- Class I, Division 1, Groups C, D
- Class I, Division 2, Group B♦, C, D
- Class II, Division 1 and 2, Groups E, F, G
- Class III
- NEMA 3, 7CD, 9EFG

Applications

- Designed to prevent arcing of enclosed switches in ignitable atmospheres during connect and disconnect operation of lighting and light power loads.
- For use in classified areas where ignitable vapors, gases or highly combustible dusts are present.
- For installation in:
 - Chemical plants
 - Petrochemical plants
 - Refineries
 - Other process industries

Features

- Enclosures have external mounting lugs for ease of mounting.
- Smooth, rounded integral bushing in each hub protects conductor insulation.
- Enclosures furnished with internal ground screw.
- 20 Amp and 30 Amp units available for use with 120-277 Vac.
- Smooth ground mating surfaces assure flame-tight joint between cover and mounting enclosure.
- Stainless steel hex head cap screws for attaching cover to mounting enclosure.
- Choice of front-operating or side rocker arm handle—each may be locked in ON or OFF position.
- Each handle has close-tolerance threaded stainless steel shaft to meet Explosionproof requirements.
- Enclosures furnished with internal ground screw.

Options

- 1- or 2-gang copperfree (4/10 of 1% max.) aluminum bodies and covers available. Add suffix – **SA**.
- NPBRKT nameplate mounting bracket to make circuit description/identification easy.
 - Pre-drilled holes in bottom of bracket allow direct mounting to control stations with existing cover bolts.
 - Pre-drilled holes in middle of bracket allow mounting of customer's circuit identification nameplate; epoxy glue may also be used for mounting (phenolic nameplate not included).
 - Bracket eliminates costly field installation of drilling and tapping to accommodate circuit identification nameplate.
 - Brackets fit side-by-side on 2-, 3- and 4-gang boxes and 3-devices.

Standard Materials

- Body and cover: malleable iron
- Handle: nylon 6/6
- Optional nameplate mounting bracket: corrosion resistant stainless steel

Standard Finishes

- Tumbler switches: triple-coat—(1) zinc electroplate, (2) chromate, and (3) epoxy powder coat

NEC/CEC Certifications and Compliances

- UL Standards: UL 894, UL 1203
- CSA Standards: C22.2 No. 14
- cULus Listed: E10449



Illustrated Features

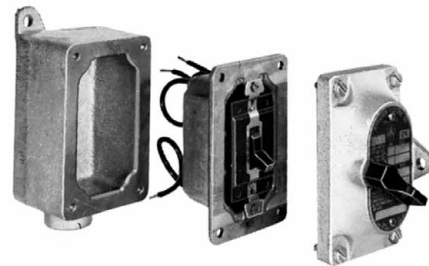

Separate sealing chamber and switch construction.
Used on 20 Amp 4-way and all 30 Amp models.



Explosionproof Labyrinth Switch
Used on all 20 Amp models excluding 4-way.

♦ Indicates items which are suitable for Class I, Division 2, Group B. See product selection pages for suitable items.





Contender™ Series Factory Sealed Front Operated Tumbler Switches

Explosionproof, Dust-Ignitionproof

Malleable Iron Body and Cover. Furnished with Internal Ground.

NEC/CEC:

- Class I, Division 1, Groups C, D
- Class I, Division 2, Group B♦, C, D
- Class II, Division 1 and 2, Groups E, F, G
- Class III
- NEMA 3, 7CD, 9EFG

	Hub Size (Inches)	Switch	Dead-End	Catalog Number ①	Feed-Thru
1-Gang					
20 Amp — 120-277 Vac ②					
	1/2	1-Pole	EDS1129 ♦		EDSC1129 ♦
	1/2	2-Pole	EDS118 ♦		EDSC118 ♦
	1/2	3-Way	EDS1130 ♦		EDSC1130 ♦
	1/2	4-Way	EDS1140		EDSC1140
Dead-End	3/4	1-Pole	EDS2129 ♦		EDSC2129 ♦
	3/4	2-Pole	EDS218 ♦		EDSC218 ♦
	3/4	3-Way	EDS2130 ♦		EDSC2130 ♦
	3/4	4-Way	EDS2140		EDSC2140
	1	1-Pole	EDS3129 ♦		EDSC3129 ♦
	1	2-Pole	EDS318 ♦		EDSC318 ♦
	1	3-Way	EDS3130 ♦		EDSC3130 ♦
	1	4-Way	EDS3140		EDSC3140
30 Amp — 120-277 Vac ③					
Feed-Thru	1	1-Pole	EDS3591		EDSC3591
	1	2-Pole	EDS3593		EDSC3593
	1	3-Way	EDS3594		EDSC3594
2-Gang					
20 Amp — 120-277 Vac ②					
	1/2	1-Pole	EDS1229 ♦		EDSC1229 ♦
	1/2	2-Pole	EDS128 ♦		EDSC128 ♦
	1/2	3-Way	EDS1230 ♦		EDSC1230 ♦
	1/2	4-Way	EDS1240		EDSC1240
Dead-End	3/4	1-Pole	EDS2229 ♦		EDSC2229 ♦
	3/4	2-Pole	EDS228 ♦		EDSC228 ♦
	3/4	3-Way	EDS2230 ♦		EDSC2230 ♦
	3/4	4-Way	EDS2240		EDSC2240
	1	1-Pole	EDS3229 ♦		EDSC3229 ♦
	1	2-Pole	EDS328 ♦		EDSC328 ♦
	1	3-Way	EDS3230 ♦		EDSC3230 ♦
	1	4-Way	EDS3240		EDSC3240
Feed-Thru					

① For Aluminum body and cover, add suffix —SA.

② 20 Amp Switches 1 HP at 120 Vac and 2 HP at 240 Vac.

③ 30 Amp Switches 2 HP at 120 Vac or 240 Vac.

♦ Contains Factory Sealed Switch; no sealing chamber. Suitable for Class I, Division 2, Group B.



CONTROLS: NEC/CEC EXPLOSIONPROOF CONTROL STATIONS AND SWITCHES

Contender™ Series Factory Sealed Front Operated Tumbler Switches

Switch Covers and Sealing Chamber/Switch Assemblies. Explosionproof, Dust-Ignitionproof

Malleable Iron Body and Cover. Furnished with Internal Ground Screw.



NE/CEC:

- Class I, Division 1, Groups C, D
- Class I, Division 2, Group B♦, C, D
- Class II, Division 1 and 2, Groups E, F, G
- Class III
- NEMA 3, 7CD, 9EFG

Factory Sealed Front Cover/Chamber/Switch Assembly

	Switch Type	Catalog Number ①	
		20 Amp 120–277 Vac ②	30 Amp 120–277 Vac ③
	1-Pole	EDSF21Q ♦	EDSF31Q
	2-Pole	EDSF22Q ♦	EDSF32Q
	3-Way	EDSF23WQ ♦	EDSF33WQ
	4-Way	EDSF24WQ	—

Cover/Switch Assembly

	Switch Type	Front Cover Only	Catalog Number	
			EFSFR Switch ④	Factory Sealed LAB Switch
	1-Pole	EDSF12	EFSFR1Q	LAB21
	2-Pole	EDSF12	EFSFR2Q	LAB22
 	3-Way	EDSF34W	EFSFR3WQ	LAB23W
	4-Way	EDSF34W	EFSFR4WQ	—

Front Cover Only

EFSFR Switch

Factory Sealed Switch Only

Nameplate Mounting Bracket

Mount bracket between cover screws and cover. Do not mount bracket between ground joint flame path between cover and backbox.

Description	Catalog Number
 <p>Bracket with blank silver/black nameplate for Contender series</p>	NPBRKT-CONT
To order bracket with control station, add suffix -NPBRKT to end of catalog number.	
To order engraved nameplates, add desired markings after catalog number. Maximum of 2 lines with 12 characters (including spaces) per line.	

① With sealing chamber.

② 20 Amp Switches 1 HP at 120 Vac and 2 HP at 240 Vac.

③ 30 Amp Switches 2 HP at 120 Vac or 240 Vac.

④ Requires the use of Code recognized sealing method as part of installation.

♦ Contains Factory Sealed Switch; no sealing chamber. Suitable for Class I, Division 2, Group B.

Contender™ Series Factory Sealed Front Operated Tumbler Switches

EDS Mounting Bodies

Furnished with Internal Ground Screw.

NEC/CEC:

Class I, Division 1, Groups C, D

Class I, Division 2, Group B, C, D

Class II, Division 1 and 2, Groups E, F, G

Class III

	Type	Hub Size (Inches)	Catalog Number	
			Malleable Iron	Aluminum
1-Gang				
	Dead-End	1/2	EDS171	EDS171-SA
		3/4	EDS271	EDS271-SA
		1	EDS371	EDS371-SA
	Feed-Thru	1/2	EDSC171	EDSC171-SA
		3/4	EDSC271	EDSC271-SA
		1	EDSC371	EDSC371-SA
2-Gang				
	Dead-End	1/2	EDS172	EDS172-SA
		3/4	EDS272	EDS272-SA
		1	EDS372	EDS372-SA
	Feed-Thru	1/2	EDSC172	EDSC172-SA
		3/4	EDSC272	EDSC272-SA
		1	EDSC372	EDSC372-SA
Tandem ①				
	Dead-End	1/2	EDS177	EDS177-SA
		3/4	EDS277	EDS277-SA
		1	EDS377	EDS377-SA
	Feed-Thru	1/2	EDSC177	EDSC177-SA
		3/4	EDSC277	EDSC277-SA
		1	EDSC377	EDSC377-SA

Appleton

CONTROLS: NEC/CEC EXPLOSIONPROOF CONTROL STATIONS AND SWITCHES

① For tandem bodies, external seals must be installed within 1.5 meters (5 feet) of each conduit entrance for Class I, Groups C and D.

Contender™ Series Factory Sealed Front Operated Tumbler Switches

NEC/CEC:

Class I, Division 1, Groups C, D
 Class I, Division 2, Group B♦, C, D
 Class II, Division 1 and 2, Groups E, F, G
 Class III
 NEMA 3, 7CD, 9EFG

Dimensions in Millimeters (Inches)

Front Operated Tumbler Switches

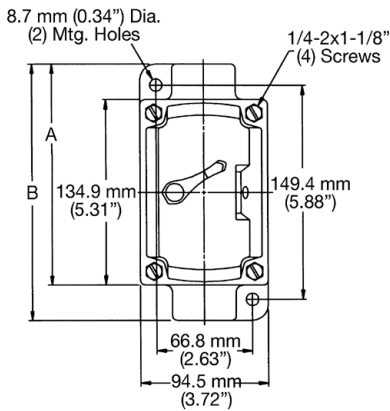

Front — 1-Gang

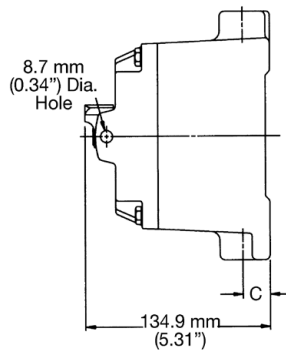

Side

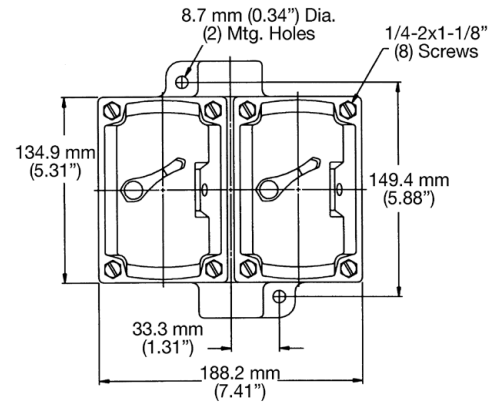

Front — 2-Gang

Dimensions in Millimeters (Inches)

Hub Size (Inches)	A	B	C
1/2 and 3/4	153.9 (6.06)	173.0 (6.81)	19.1 (0.75)
1	156.7 (6.17)	178.6 (7.03)	25.4 (1.00)

Dimensions in Millimeters (Inches)

NPBRKT Nameplate Mounting Bracket

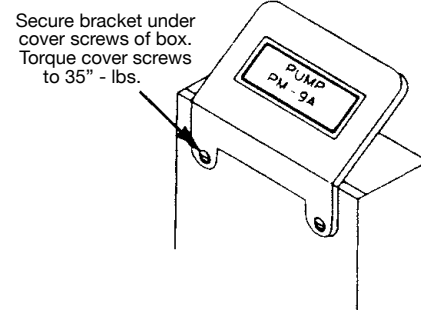
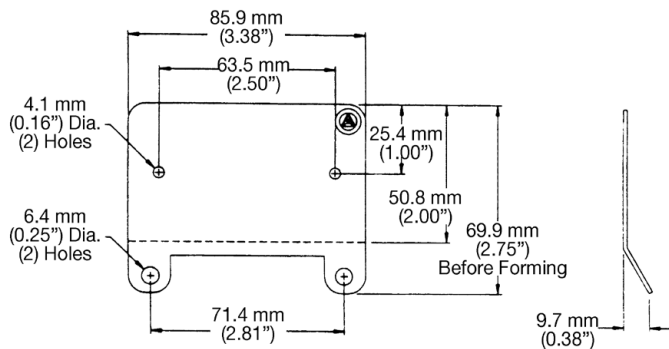

♦ Indicates items which are suitable for Class I, Division 2, Group B. See product selection pages for suitable items.

CONTROLS: NEC/CEC EXPLOSIONPROOF CONTROL STATIONS AND SWITCHES

